

**F. Dandy architecture**

**F. Dandy circuit / PCB**

**John / Nathan System Integration**

**Rev : 1.0 12.12.19**

**Page 1/2**

**AMPduino Audio Amplifier Control Shield (A3CS) Schematic Diagram**

A3CS is Arduino Uno form factor Shield, a special module designed for controlling Amplifier using Arduino Uno or riichaUNO Board

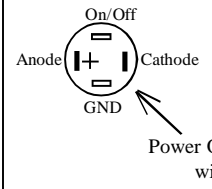

CON5 is 2 point Connector 2.54mm pitch

Power Port

CON24

A3CS Module Power Supply

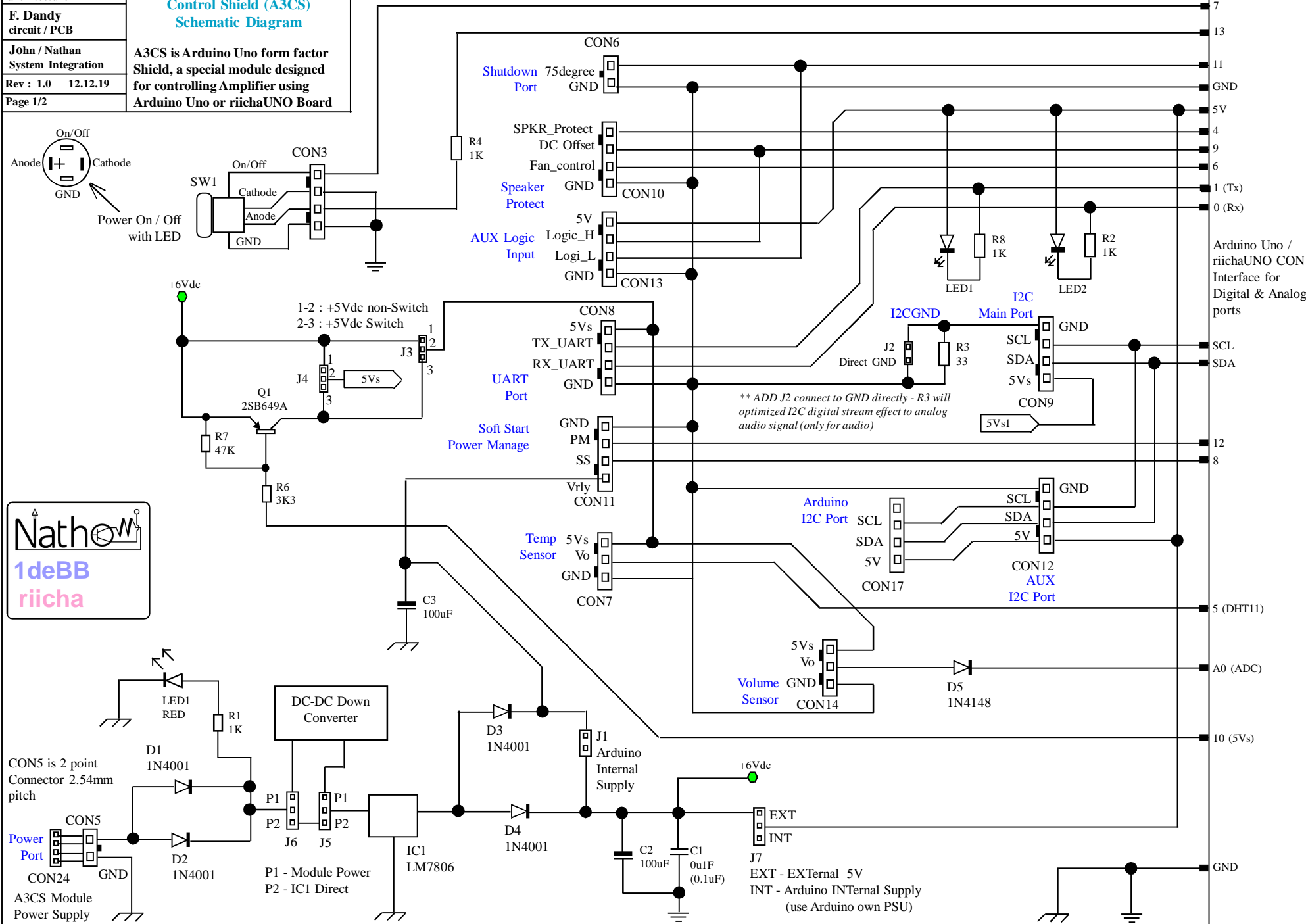

Arduino Uno / riichaUNO CON Interface for Digital & Analog ports

- 7
- 13
- 11
- GND
- 5V
- 4
- 9
- 6
- 1 (Tx)
- 0 (Rx)
- 12
- 8
- 5 (DHT11)
- A0 (ADC)
- 10 (5Vs)
- GND

<b>F. Dandy architecture</b>	<p><b>AMPduino Audio Amplifier Control Shield (A3CS) Schematic Diagram</b></p> <p>A3CS is Arduino Uno form factor Shield, a special module designed for controlling Amplifier using Arduino Uno or riichaUNO Board</p>
<b>F. Dandy circuit / PCB</b>	
<b>John / Nathan System Integration</b>	
<b>Rev : 1.0 12.12.19</b>	
<b>Page 2/2</b>	

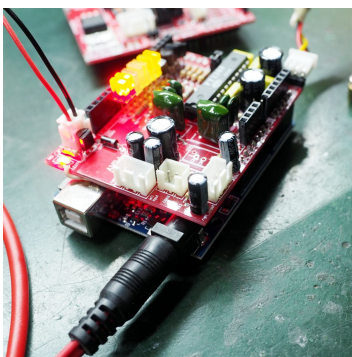
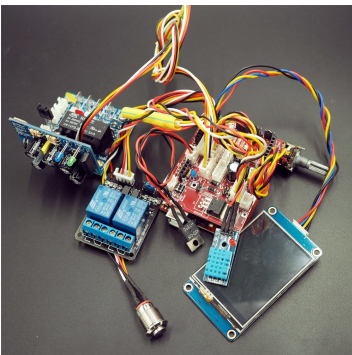
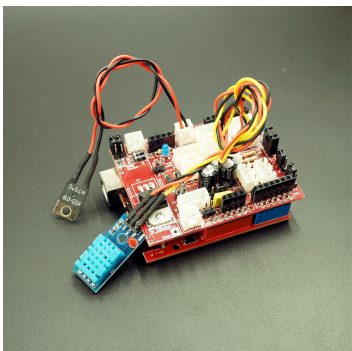

C collaborate  
 A access  
 L learn  
 A avail  
 S share  
 S support



**1deBB**  
 1diy electronic Building Block  
**riicha**  
 research-innovation-industrial-commercial-hobby- automation

Congratulation for having the [AMPduino Schematic](#) Diagram.

The AMPduino Project is created by F. Dandy of 1diySHARE.com - Baguio city, *The Philippines* as a part of “Arduino Discoveries”. Thanks to Arduino Team (arduino.cc) for having the Arduino Solution specially to the humble Arduino Uno where I started my hardware and software adventure.

AMPduino Project is a Series of SHIELDS developed for personal use and dedicated for [DIY Amplifier Builders](#) - a shareware and courseware.

**1. AMPduino-A3CS**

This is a shield for Arduino Uno acts as a Controller with easy plug & play of connectors to sensors, DHT11, Thermostat, Relays, LCD and Push Buttons

**2. AMPduino - PeQS**

This is a shield for Arduino Uno acts as a Preset Equalizer that enhanced Audio experience with effects such as :  
 - Rock, Pop, Jazz, Classics, Normal, Turbo Bass, 3d sounds

**3. AMPduino - 3BTS**

This is a shield for Arduino Uno acts as a digital 3 Band Tone Control : Bass-Mid-Treble, to tailor your own taste of music

**4. AMPduino - XXXYYY**

I keep on thinking to develop more shield that I can plug & play into the 3 shields originally conceived above.

If you like the idea, the method of DIY Learning, the Project Kindly Support this Project to move forward to its intention as a part of Arduino Discoveries in the DIY Audio Hobby. I posted several Tutorial Video in youtube (on keep posting) : [D Stuffs Channel](#), thank you very much for your support, by subscribing to my Youtube Channel, it can keep me using it for free to post free videos, Like my videos and share to your circle of friends who need it.

Support this Project by actively participating, by making it more of a DIY Learning, boost my handicap to explain and impart and create more Audio hardware that can expand the original idea. *Salamat Po!*

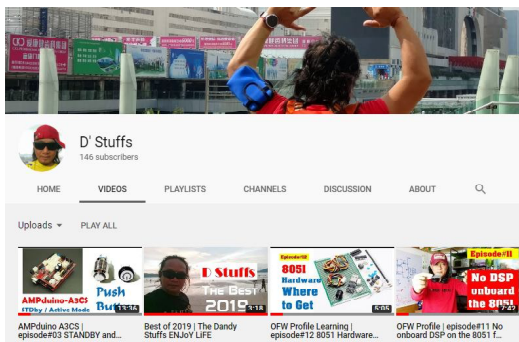

email : dandymenor@hotmail.com

Find me @ :  
 ENJOY LiFe : [www.1diySHARE.com](http://www.1diySHARE.com)

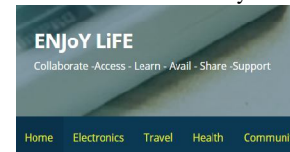

@DandyADventure : [www.facebook.com](http://www.facebook.com)



The DIY Hobbyist Corner : [www.elab.ph](http://www.elab.ph)

